



FEATHER MICROTOME HOLDER No.160



www.feather.co.jp/en/m_products/
www.pfmmedical.com/downloads
eIFU is available in: English, Deutsch, Français,
Español, Italiano, Português, Nederlands

Instructions for use

The device's intended purpose

- This device is intended to be attached to the dedicated microtome blade and used for thin-sectioning of tissue that has been processed for pathological examination.
- Dedicated blade: FEATHER MICROTOME BLADE, Low Profile (with the exception of S35L and S35LL) ● This device is intended for laboratory professional use.

Contents

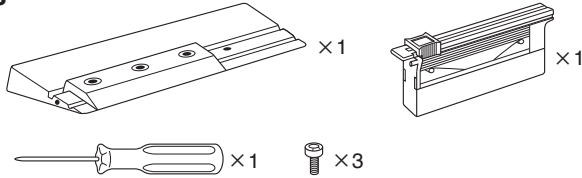

Position of the blade fixing plate

For sliding microtome

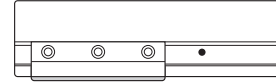

For rotary microtome

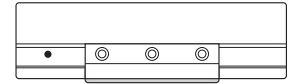

How to clamp the disposable microtome blade

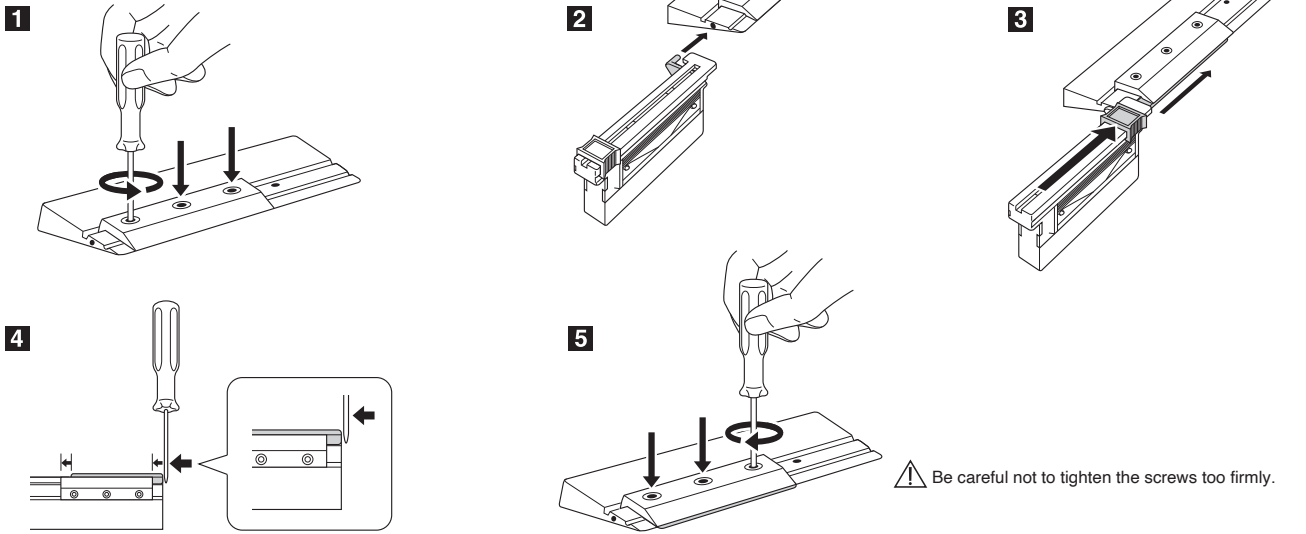

Caution Precautions for use

1. The products are only for medical use. Disposable microtome blades are extremely sharp, so please use them with care. Used microtome blades can be safely kept in the part of the dispenser marked accordingly.
2. To insert a new disposable microtome blade, please use the insertion device on the microtome blade holder or dispenser.
3. Make sure to fix the microtome blade holder at a clearance angle of at least 5°.
- 4.

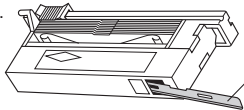

Used microtome blades can be safely kept in the part of the dispenser marked accordingly.

5. The disposable microtome blades have been treated with anti-corrosion oil. This will not cause any problems for the sectioning process, so removal of the oil is not necessary.
6. Disposable microtome blades will quickly become dull if used for paraffin blocks which have not been well infiltrated with paraffin, for sectioning non-decalcified tissues or tissues having minute structures.

Safety and care instructions

1. Wipe the surface of the microtome blade holder daily using machine oil. Although the holder is made of alloyed tool steel and is rust-resistant, moisture and fingermarks could cause rust.
2. Handle with care in order not to damage the precision ground edge of the microtome blade holder.
3. Prior to storing the microtome blade holder for a longer period of time, fully disassemble all the parts and apply some oil to all surfaces, including the grooves, fixing plates and screw holes.
4. Any serious incident that has occurred in relation to the device shall be reported to the manufacturer and the competent authority of the Member State in which the user and/or the patient is established.

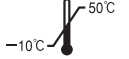

pfm medical gmbh
Wankelstr. 60, 50996 Köln, Germany
T +49(0)2236 9641-0, F -20
www.pfmmedical.com



FEATHER SAFETY RAZOR CO., LTD.

3-70, OHYODO-MINAMI 3-CHOME, KITA-KU, OSAKA 531-0075, JAPAN
www.feather.co.jp/en

MADE IN JAPAN



Symbols glossary

	Manufacturer		Catalog number		Keep away from sunlight		Consult instructions for use		Batch code		Do not use if package is damaged and consult instructions for use
	Authorized representative in the European Community/European Union		Importer		Keep dry		Caution		Temperature limit		In Vitro Diagnostic Medical Device



FEATHER MICROTOME HOLDER No.160

Mikrotomklingenhalter Nr.160

www.feather.co.jp/en/m_products/
www.pfmmedical.com/download
 eIFU is available in: English, Deutsch, Français, Español, Italiano, Português, Nederlands

Gebrauchsanweisung

Anwendung

- Dieses Produkt ist für die Aufnahme passender Mikrotomklingen bestimmt. Es wird für Dünnschnitte von Gewebe für pathologische Untersuchungen verwendet.
- Passende Klingen: FEATHER MIKROTOMKLINGE, Low Profile (mit Ausnahme von S35L und S35LL) ●Das Produkt ist für professionelle Laboranwendungen bestimmt.

Inhalt

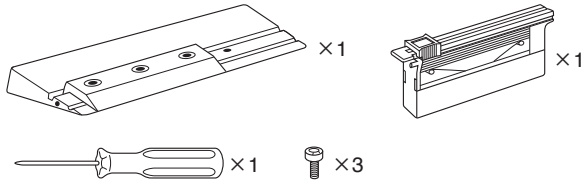

Position der Andruckplatte für die Mikrotomklinge

Für Schlittenmikrotome

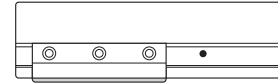

Für Rotationsmikrotome



Einspannen der Mikrotomklinge

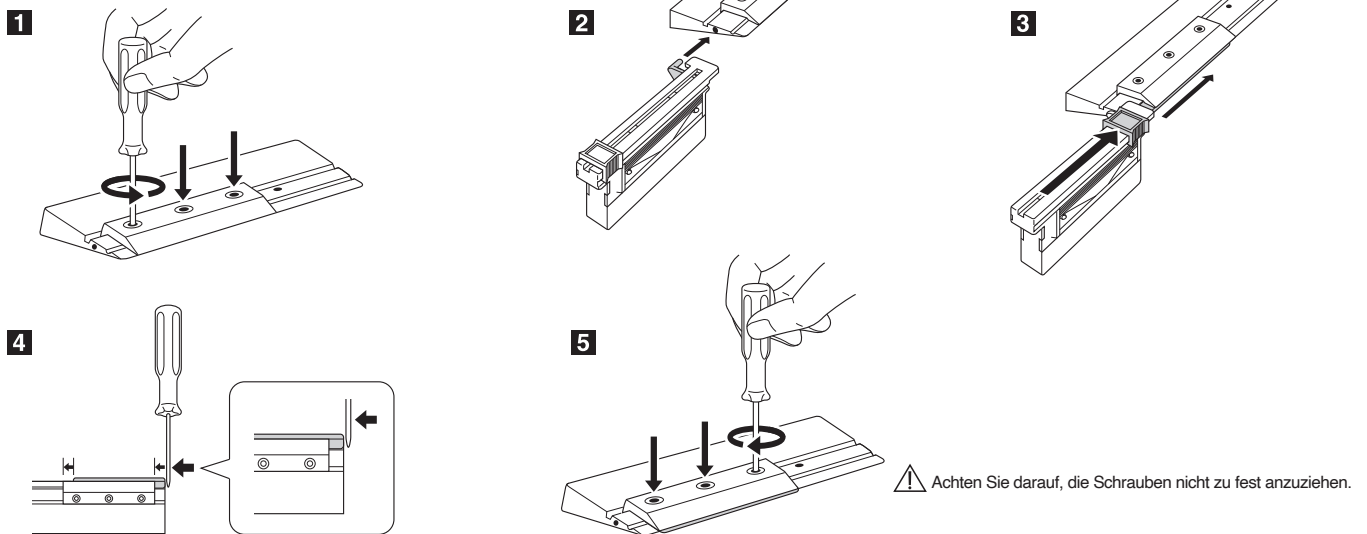

Achtung

Vorsichtsmassnahmen für den Gebrauch

1. Produkt nur für den medizinischen Gebrauch. Vorsicht beim Umgang mit Mikrotomklingen, sie sind extrem scharf. Verbrauchte Mikrotomklingen können im gekennzeichneten Teil des Dispensers sicher aufbewahrt werden.
2. Bitte benutzen Sie zum Einführen einer neuen Mikrotomklinge die Einführhilfe am Mikrotomklingenhalter bzw. Dispenser.
3. Stellen Sie sicher, dass Sie den Mikrotomklingenhalter mit einem Freiwinkel von mindestens 5° einspannen.
- 4.

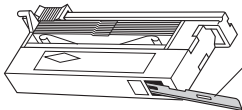

Verbrauchte Mikrotomklingen können im gekennzeichneten Teil des Dispensers sicher aufbewahrt werden.

5. Die Mikrotomklingen sind mit Rostschutzöl beschichtet. Dies verursacht keine Probleme beim Schneiden. Es ist daher nicht notwendig, das Öl zu entfernen.
6. Mikrotomklingen werden schnell stumpf, wenn die Paraffinblöcke nicht optimal mit Paraffin infiltriert wurden, nicht entkalktes Gewebe oder Gewebe mit sehr feinen Strukturen geschnitten wird.

Sicherheits- und Pflegehinweise

1. Wischen Sie die Oberfläche des Mikrotomklingenhalters täglich mit Maschinenöl ab. Obwohl der Halter aus legiertem Werkzeugstahl gefertigt und widerstandsfähig gegen Rost ist, können Feuchtigkeit und Fingerabdrücke zu Rost führen.
2. Gehen Sie vorsichtig damit um, um die geschliffene Präzisionskante des Mikrotomklingenhalters nicht zu beschädigen.
3. Bevor Sie den Mikrotomklingenhalter über eine längere Zeit lagern, bauen Sie alle Teile auseinander und tragen Sie etwas Öl auf alle Oberflächen auf, einschließlich der Rillen, Befestigungsplatten und Schraubenlöcher.
4. Alle im Zusammenhang mit dem Produkt aufgetretenen schwerwiegenden Vorkommnisse sind dem Hersteller und der zuständigen Behörde des Mitgliedstaats, in dem der Anwender und/oder der Patient niedergelassen ist, zu melden.

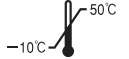

pfmmedical

pfm medical gmbh
 Wankelestr. 60, 50996 Köln, Germany
 T +49(0)2236 9641-0, F -20
www.pfmmedical.com



FEATHER SAFETY RAZOR CO., LTD.

3-70, OHYODO-MINAMI 3-CHOME, KITA-KU, OSAKA 531-0075, JAPAN
www.feather.co.jp/en

MADE IN JAPAN



Symbolglossar

	Hersteller		Katalognummer		Vor Sonnenlicht schützen		Gebrauchsanweisung beachten		Chargennummer		Bei beschädigter Verpackung nicht verwenden und Gebrauchsanweisung beachten
	Bevollmächtigter in der Europäischen Gemeinschaft /Europäischen Union		Importeur		Trocken aufbewahren		Achtung		Temperaturbegrenzung		In-vitro-Diagnostikum



FEATHER MICROTOME HOLDER No.160

Porte-lame microtome No.160



www.feather.co.jp/en/m_products/

www.pfmmedical.com/downloads

eFU is available in; English, Deutsch, Français, Español, Italiano, Português, Nederlands

Instructions D'utilisation

L'utilisation conforme à la destination prévue du dispositif

●Le dispositif est destiné à être monté sur la lame de microtome compatible et sert à sectionner finement des tissus après traitement pour examen pathologique.

●Lame compatible : LAME DE MICROTOME FEATHER, Low Profile (à l'exception de S35L et S35LL) ●Le dispositif est destiné à un emploi professionnel en laboratoire.

Contenu

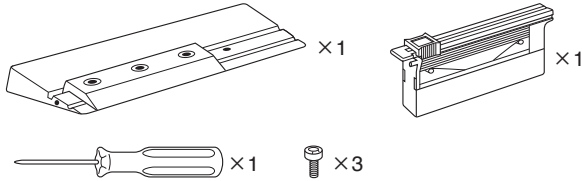

Position de la plaque de fixation de la lame

Pour microtome à glissière

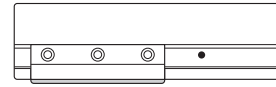

Pour microtome rotatif

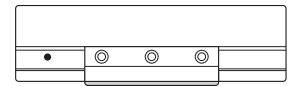

Serrage De La Lame Pour Microtome

1

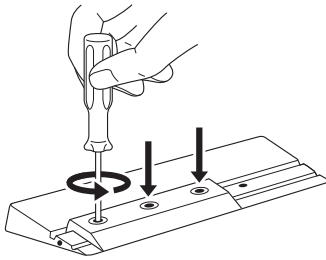

2

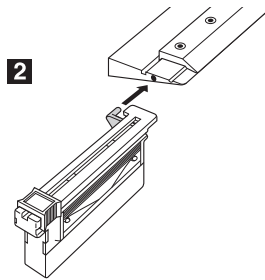

3

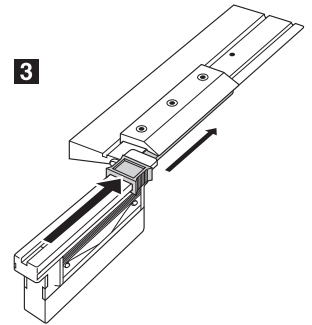

4

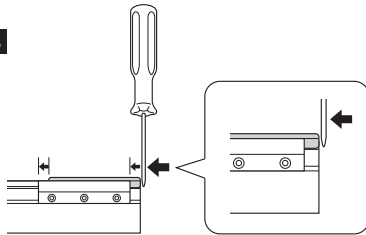

5

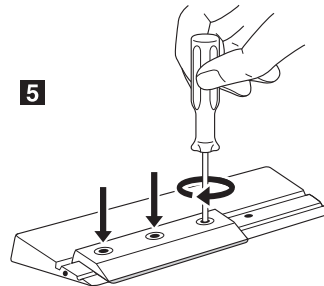

⚠ Veillez à ne pas serrer les vis trop fermement.

⚠ Avertissement Précautions D'emploi

1. Les produits sont uniquement destinés à un usage médical. Les lames pour microtome sont extrêmement tranchantes. Prenez garde lors de leur manipulation. Les lames de microtome usagées peuvent être conservées en toute sécurité dans la partie désignée à cet effet du distributeur.
2. Utiliser l'aide à l'insertion du porte-lame ou du distributeur pour insérer une nouvelle lame pour microtome.
3. Assurez-vous que le porte-lame soit serré avec un angle de dépouille d'au moins 5°.

4.

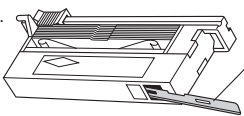

Les lames de microtome usagées peuvent être conservées en toute sécurité dans la partie désignée à cet effet du distributeur.

5. Les lames pour microtome sont recouvertes d'huile antirouille. Cette dernière n'entraîne aucun problème pour la découpe. Il n'est donc pas nécessaire de la retirer.
6. Les lames pour microtome s'émoussent rapidement lorsque les blocs de paraffine ne sont pas gorgés de paraffine de manière optimale ou bien en cas de coupe de tissus non décalcifiés ou de tissus présentant des structures très fines.

Instructions de sécurité et d'entretien

1. Essuyez la surface du porte-lame pour microtome quotidiennement avec de l'huile de machine. Bien que le porte-lame soit en acier à outils alliés et fortement résistant à l'oxydation, l'humidité et les traces de doigt peuvent entraîner une oxydation.
2. Manipulez avec précaution afin de ne pas endommager la précision d'affûtage du bord du porte-lame pour microtome.
3. Avant de ranger le porte-lame pour microtome pour une longue période, désassemblez complètement toutes les pièces et appliquez de l'huile sur chaque surface, y compris les rainures, les plaques de fixation et les trous de visserie.
4. Tout incident grave survenu en lien avec le dispositif doit être fait l'objet d'une notification au fabricant et à l'autorité compétente de l'État membre dans lequel l'utilisateur et/ou le patient est établi.

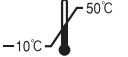

pfmmedical

pfm medical gmbh
Wankelstr. 60, 50996 Köln, Germany
T +49(0)2236 9641-0, F-20
www.pfmmedical.com



FEATHER SAFETY RAZOR CO., LTD.

3-70, OHYODO-MINAMI 3-CHOME, KITA-KU, OSAKA 531-0075, JAPAN
www.feather.co.jp/en

MADE IN JAPAN



Glossaire des symboles

	Fabricant		Référence catalogue		Conserver à l'abri de la lumière		Consulter le mode d'emploi		Code du lot		Ne pas utiliser si l'emballage est endommagé et consulter le mode d'emploi
	Mandataire dans la Communauté européenne /Union européenne		Importateur		Garder au sec		Attention		Limite de température		Dispositif médical de diagnostic in vitro



FEATHER MICROTOME HOLDER No.160

Soporte de cuchillas de micrótopo NO.160

Instrucciones De Uso



www.feather.co.jp/en/m_products/
www.pfmmedical.com/downloads
eIFU is available in; English, Deutsch, Français,
Español, Italiano, Português, Nederlands

El uso previsto del producto

- Este producto está previsto para su acoplamiento a la cuchilla específica para microtomo y para ser utilizado para el corte fino de tejido que haya sido procesado para su examen patológico.
- Cuchilla específica: CUCHILLA PARA MICROTOMO FEATHER, Low Profile (excepto S35L y S35LL) ●Este producto está previsto para su uso profesional en el laboratorio.

Contenidos

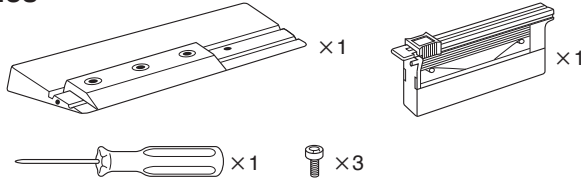

Posición del portacuchillas

Para microtomo de deslizamiento

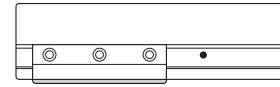

Para microtomo de rotación

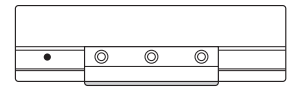

Como Fijar La Cuchilla Para Micrótopo

1

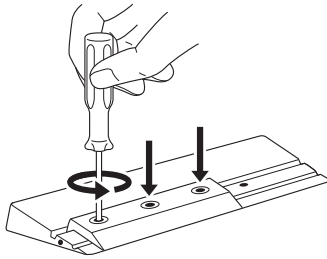

2

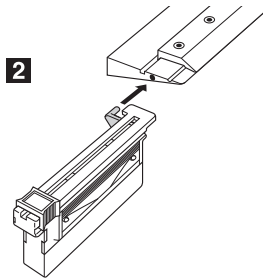

3

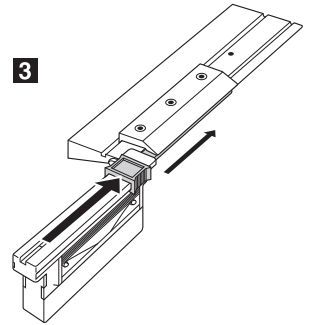

4

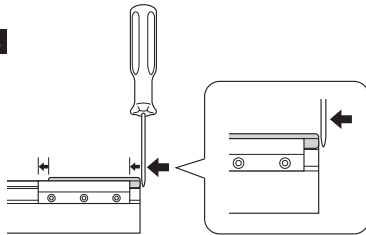

5

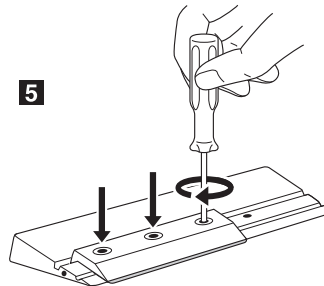

⚠ Tenga cuidado de no ajustar demasiado los tornillos.

Atención Precauciones De Uso

- 1.Productos para uso médico exclusivamente. Las cuchillas de micrótopo están extremadamente afiladas. Tenga cuidado al manejarlas. Las cuchillas usadas pueden guardarse de manera segura en la parte de la caja dispensadora marcada a tal efecto.
- 2.Para insertar una nueva cuchilla de micrótopo, utilice por favor la ayuda de inserción en el soporte de cuchillas o en la caja dispensadora.
- 3.Asegúrese de fijar el soporte de cuchillas del micrótopo en un ángulo de incidencia de al menos 5°.

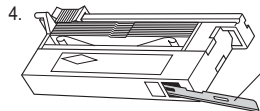

Las cuchillas usadas pueden guardarse de manera segura en la parte de la caja dispensadora marcada a tal efecto.

- 5.Las cuchillas de micrótopo están revestidas con aceite antioxidante. Esto no ocasiona problemas durante el seccionamiento, por lo que no es necesario removerlo.
- 6.Las cuchillas de micrótopo perderán el filo rápidamente si los bloques de parafina no han sido infiltrados óptimamente con parafina o si se cortan tejidos no descalcificados o tejidos que tienen estructuras muy finas.

Instrucciones de seguridad y cuidado

- 1.Limpiar la superficie del soporte para cuchillas de micrótopo diariamente con aceite para máquinas. A pesar de que el soporte está hecho de una aleación de acero para herramientas resistente a la oxidación, la humedad y marcas dactilares pueden ocasionar oxidación.
- 2.Maneje teniendo cuidado para no dañar el acabado de precisión del borde del soporte de cuchillas.
- 3.Antes de almacenar el soporte de cuchillas por largos periodos de tiempo, desmonte completamente las piezas y aplique un poco de aceite a todas las superficies, incluyendo las ranuras, placas de fijación y agujeros de los tornillos.
- 4.Cualquier incidente grave que se haya producido en relación con el producto deberá notificarse al fabricante y a la autoridad competente del Estado miembro en el que esté establecido el usuario y/o el paciente.

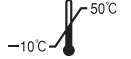

pfmmedical

pfm medical gmbh
Wankelstr. 60, 50996 Köln, Germany
T +49(0)2236 9641-0, F-20
www.pfmmedical.com



FEATHER SAFETY RAZOR CO., LTD.

3-70, OHYODO-MINAMI 3-CHOME, KITA-KU, OSAKA 531-0075, JAPAN
www.feather.co.jp/en

MADE IN JAPAN



Glosario de símbolos

	Fabricante		Número de catálogo		Mantener alejado de la luz solar		Consultar las instrucciones de uso		Código de lote		No utilizar si el envase está dañado y consultar las instrucciones de uso
	Representante autorizado en la Comunidad Europea/Unión Europea		Importador		Mantener seco		Precaución		Límite de temperatura		Dispositivo médico de diagnóstico in vitro



FEATHER MICROTOME HOLDER No.160

Portalama microtomo No.160



www.feather.co.jp/en/m_products/
www.pfmmedical.com/downloads
eFU is available in; English, Deutsch, Français,
Español, Italiano, Português, Nederlands

Istruzioni Per L'uso

Destinazione d'uso del dispositivo

- Questo dispositivo è destinato al collegamento alla lama per microtomo dedicata e utilizzato per effettuare il sezionamento sottile del tessuto che è stato trattato per l'esame patologico.
- Lama dedicata: LAMA PER MICROTOMO FEATHER, Low Profile (ad eccezione di S35L e S35LL) ●Questo dispositivo è destinato all'uso professionale in laboratorio.

Contenuti

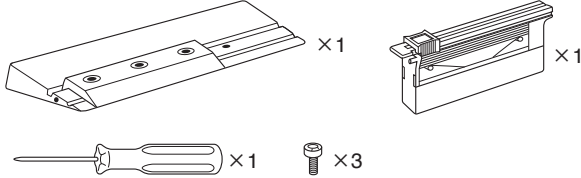

Posizione della piastra per fissare la lama microtomo

Per microtomo a slitta

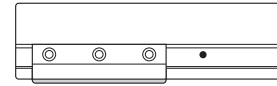

Per microtomo rotativo

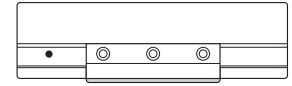

Come Fissare La Lama Per Microtomo

1

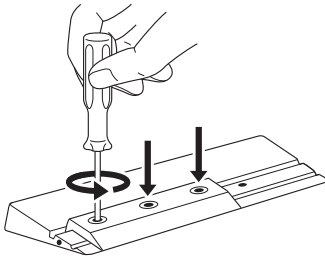

2

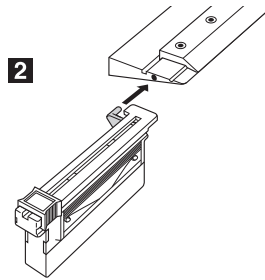

3

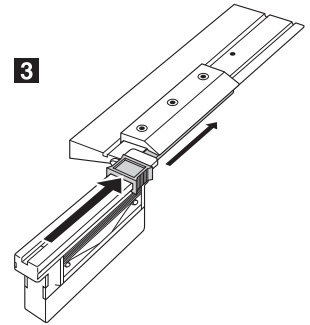

4

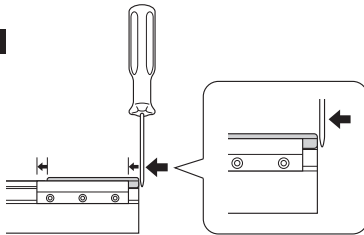

5

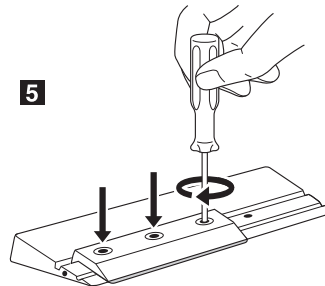

⚠ Fare attenzione a non serrare eccessivamente le viti.

⚠ Attenzione Precauzioni D'Uso

- I prodotti sono esclusivamente per uso medico. Le lame per microtomo sono estremamente taglienti. Maneggiarle con attenzione. Le lame usate possono essere conservate in modo sicuro nell'apposita sezione contrassegnata del dispenser.
- Per l'inserimento di una nuova lama per microtomo utilizzare il dispositivo di ausilio sul portalama del microtomo e/o sul dispenser.
- Accertarsi di aver fissato il portalama per microtomo a un angolo di spoglia di almeno 5°.

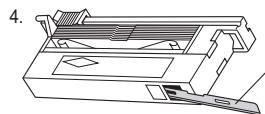

Le lame usate possono essere conservate in modo sicuro nell'apposita sezione contrassegnata del dispenser.

- Le lame per microtomo sono rivestite di olio antiruggine. Non è necessario rimuovere l'olio, in quanto non causa alcun problema al sezionamento.
- Le lame per microtomo si smussano rapidamente se usate su blocchetti non ben infiltrati di paraffina, su tessuti non decalcificati o su tessuti con strutture molto sottili.

Istruzioni per la sicurezza e la cura

- Pulire quotidianamente la superficie del portalama per microtomo con olio da macchina. Sebbene il portalama sia in lega d'acciaio da utensili e sia resistente alla ruggine, l'umidità e le ditate potrebbero arrugginirlo.
- Maneggiare con cura per evitare di danneggiare la finitura rettificata di precisione sul bordo del portalama per microtomo.
- Prima di riporre il portalama per microtomo per lunghi periodi, smontare completamente tutte le parti e applicare dell'olio su tutte le superfici, incluso le scanalature, le piastrine di fissaggio e i fori delle viti.
- Qualsiasi incidente grave verificatosi in relazione al dispositivo deve essere segnalato al fabbricante e all'autorità competente dello Stato membro in cui l'utilizzatore e/o il paziente è stabilito.

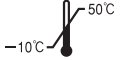

pfmmedical

pfm medical gmbh
Wankelstr. 60, 50996 Köln, Germany
T+49(0)2236 9641-0, F-20
www.pfmmedical.com



FEATHER SAFETY RAZOR CO., LTD.

3-70, OHYODO-MINAMI 3-CHOME, KITA-KU, OSAKA 531-0075, JAPAN
www.feather.co.jp/en

MADE IN JAPAN



Glossario dei simboli

	Produttore		Numero di catalogo		Conservare lontano dai raggi solari		Consultare le istruzioni per l'uso		Codice di lotto		Non utilizzare se la confezione è danneggiata e consultare le istruzioni per l'uso
	Rappresentante autorizzato nella Comunità europea/Unione europea		Importatore		Mantenere asciutto		Attenzione		Limite di temperatura		Dispositivo medico diagnostico in vitro



FEATHER MICROTOME HOLDER No.160

Suporte de lâmina de microtomia N.º160

Instruções De Utilização



www.feather.co.jp/en/m_products/
www.pfmmedical.com/downloads
 eIFU is available in: English, Deutsch, Français, Español, Italiano, Português, Nederlands

A finalidade prevista para o dispositivo

- Este dispositivo destina-se a ser unido à lâmina de micrótomo dedicada e é utilizado para o corte fino do tecido processado para fins de exame patológico.
- Lâmina dedicada: LÂMINA PARA MICRÓTOMO FEATHER, Low Profile (com exceção de S35L e S35LL)
- Este dispositivo destina-se a uma utilização profissional em ambiente laboratorial.

Conteúdo

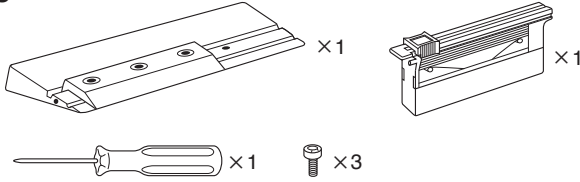

Posição da placa de fixação da lâmina

Para micrótomo deslizante

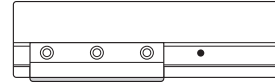

Para micrótomo rotativo



Como Fixar A Lâmina De Micrótomo

1

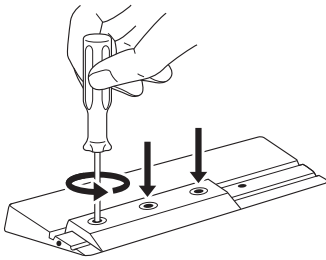

2

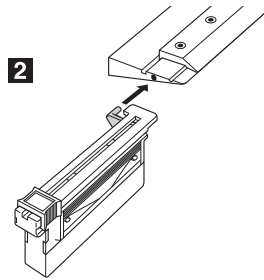

3

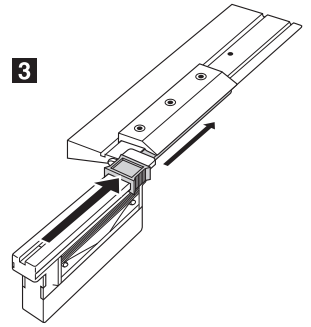

4

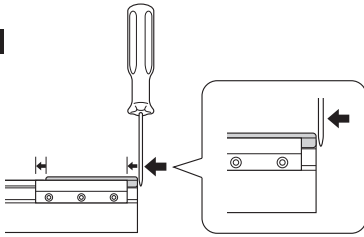

5

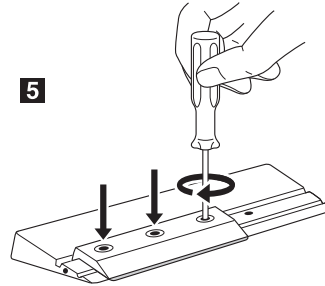

⚠ Tenha o cuidado de não apertar demasiado os parafusos.

Atenção Precauções De Utilização

- Os produtos são unicamente para uso médico. As lâminas do micrótomo são extremamente afiadas. Tenha cuidado ao manejá-las. As lâminas gastas podem ser guardadas em segurança na parte identificada do dispensador.
- Para a introdução de uma nova lâmina de micrótomo, use a patilha de auxílio à introdução no suporte de lâminas de micrótomo ou no dispensador.
- Certifique-se de que fixa o suporte de lâminas de micrótomo com um ângulo de incidência de, no mínimo, 5°.
- As lâminas gastas podem ser guardadas com segurança na parte identificada do dispensador.
- As lâminas de micrótomo estão revestidas com óleo antiferrugem. Não é necessário remover o óleo, uma vez que este não causa problemas durante o seccionamento.
- As lâminas de micrótomo ficam rapidamente rombas, se forem usadas em blocos de parafina que não tenham sido impregnados optimamente com parafina, em tecidos não descalcificados ou em tecidos de estruturas muito finas.

Instruções de segurança e cuidados

- Limpe diariamente a superfície do suporte de lâminas de micrótomo com óleo de máquinas. Apesar de o suporte ser fabricado em liga de aço para ferramentas e ser resistente à ferrugem, a humidade e as marcas dos dedos podem provocar ferrugem.
- Manuseie com cuidado para não danificar o acabamento esmerilado de precisão da extremidade do suporte de lâminas de micrótomo.
- Antes de guardar o suporte de lâminas de micrótomo durante um longo período de tempo, desmonte totalmente todas as peças e aplique algum óleo em todas as superfícies, incluindo as ranhuras, as placas de fixação e os orifícios dos parafusos.
- Qualquer incidente grave que tenha ocorrido associado ao dispositivo deve ser comunicado ao fabricante e à autoridade competente do Estado-membro em que o utilizador e/ou o paciente se encontra estabelecido.

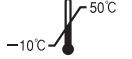

pfmmedical

pfm medical gmbh
 Wankelstr. 60, 50996 Köln, Germany
 T +49(0)2236 9641-0, F -20
www.pfmmedical.com



FEATHER SAFETY RAZOR CO., LTD.

3-70, OHYODO-MINAMI 3-CHOME, KITA-KU, OSAKA 531-0075, JAPAN
www.feather.co.jp/en

MADE IN JAPAN



Glossário de símbolos

	Fabricante		Número de catálogo		Manter afastado da luz solar		Consulte as instruções de utilização		Código de lote		Não utilize se a embalagem estiver danificada e consulte as instruções de utilização
	Representante autorizado na Comunidade Europeia União Europeia		Importador		Manter seco		Cuidado		Limite de temperatura		Dispositivo médico de diagnóstico in vitro



FEATHER MICROTOME HOLDER No.160

Microtoommeshouder Nr.160



www.feather.co.jp/en/m_products/
www.pfmmedical.com/downloads
eIFU is available in: English, Deutsch, Français,
Español, Italiano, Português, Nederlands

Gebruiksaanwijzing

Het beoogde doeleinde van het hulpmiddel

- Dit hulpmiddel is bedoeld voor bevestiging aan het speciale microtoommes en gebruik voor de dunne ontleding van weefsels dat is bewerkt voor pathologisch onderzoek.
- Passend mes: FEATHER MICROTOOMMES, Low Profile (met uitzondering van S35L en S35LL) ●Dit hulpmiddel is bedoeld voor professioneel gebruik in laboratoria.

Inhoud

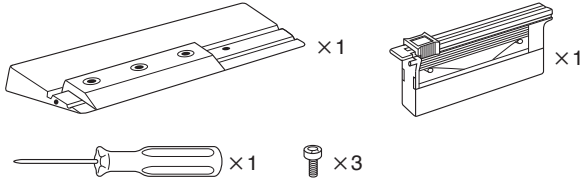

Positie van het microtoom mesje aandrukplaat

Voor Siede microtomen

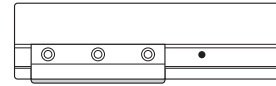

Voor Rotatie microtomen



Het Microtoommesje Fixeren

1

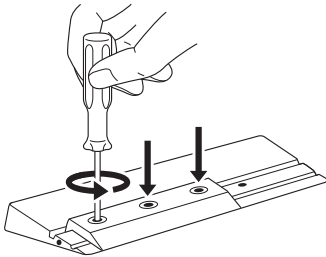

2

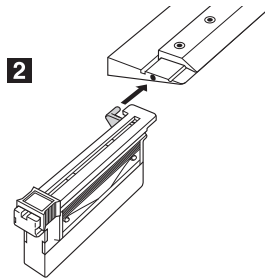

3

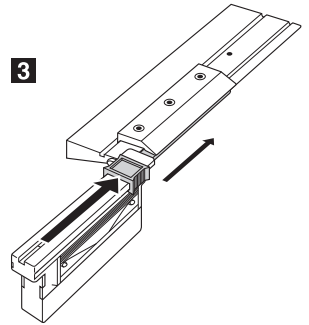

4

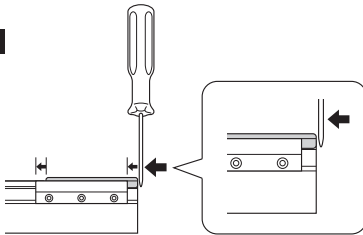

5

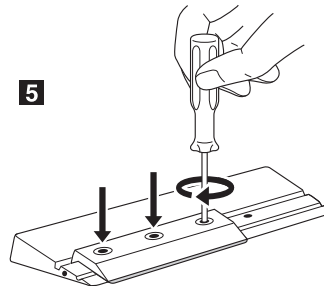

⚠ Let op dat u de schroeven niet te hard aandraait.

⚠ Opgelet

Voorzorgsmaatregelen Bij GEebruik

1. Deze producten zijn uitsluitend voor medisch gebruik. Microtoommesjes zijn uitermate scherp. Wees voorzichtig met het gebruik ervan. Gebruikte microtoommesjes kunt u in het gekenmerkte gedeelte van de dispenser veilig opbergen.
2. Gelieve voor het invoeren van een nieuw microtoommesje de invoerhulp aan de microtoommesjeshouder of dispenser te gebruiken.
3. Fixeer de microtoommesjeshouder in ieder geval met een vrijloophoek van min. 5°.
- 4.

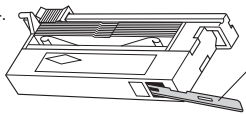

Gebruikte microtoommesjes kunt u in het gekenmerkte gedeelte van de dispenser veilig opbergen.

5. De microtoommesjes zijn gecoat met antiroestolie. Dit geeft geen problemen bij het snijden. Het is dus niet nodig de olie te verwijderen.
6. Microtoommesjes worden snel bot wanneer de paraffineblokken niet optimaal doordrenkt zijn met paraffine of wanneer niet-ontkalkte weefsels of weefsels met heel fijne structuren worden gesneden.

Veiligheids- en onderhoudsinstructies

1. Veeg het oppervlak van de microtoommesjeshouder dagelijks af met machineolie. Hoewel de houder uit gelegeerd gereedschapsstaal is vervaardigd en zeer roestbestendig is, is het mogelijk dat vocht en vingerafdrukken tot roest leiden.
2. Ga voorzichtig met het product om, zodat u de precisiegeslepen afwerking van de rand van de microtoommesjeshouder niet beschadigt.
3. Als u de microtoommesjeshouder een geruime tijd niet gebruikt, demonteer dan alle onderdelen en besprenkel alle oppervlakken met een beetje olie, inclusief de groeven, bevestigingsplaten en schroefgaten.
4. Elk ernstig incident in verband met het hulpmiddel moet worden gemeld aan de fabrikant en aan de bevoegde autoriteit van de lidstaat waar de gebruiker en/of de patiënt is gevestigd.



pfmmedical

pfm medical gmbh
Wankelstr. 60, 50996 Köln, Germany
T +49(0)2236 9641-0, F -20
www.pfmmedical.com



FEATHER SAFETY RAZOR CO., LTD.

3-70, OHYODO-MINAMI 3-CHOME, KITA-KU, OSAKA 531-0075, JAPAN
www.feather.co.jp/en



MADE IN JAPAN

Verklaring van de symbolen

	Fabrikant		Catalogusnummer		Uit de buurt van zonlicht houden		Raadpleeg gebruiksaanwijzing		Batchcode		Niet gebruiken als de verpakking beschadigd is en raadpleeg de gebruiksaanwijzing
	Gemachtigde vertegenwoordiger in de Europese Gemeenschap/ Europese Unie		Importeur		Blijf droog		Let op		Temperatuurgrens		In vitro diagnostisch medisch hulpmiddel